



CLASSIC Wood Mouldings

QUALITY MOULDINGS & INTERIOR DOOR SETS

www.classicwoodmouldings.com

CENTRAL OTTAWA

210 COLONNADE ROAD SOUTH
613.225.4782

OTTAWA EAST

1528 STAR TOP ROAD
613.748.5000

OTTAWA WEST

435 MOODIE DRIVE
613.820.8000

TORONTO

24 RONSON DRIVE
416.241.9380

A modern living and office space. On the left, a white-framed glass door leads to a wooden deck. The wall is covered in light-colored vertical wood paneling. A framed picture of a ship, titled "BLUE STAR LINE NORTH AMERICA", hangs on the wall. In the center, a dark wood desk with a black leather office chair is set up. To the right, a light-colored sofa with several patterned and solid-colored pillows is positioned. A wooden coffee table sits in front of the sofa. Large windows with white blinds are in the background, and a floor lamp stands near them. The floor is made of light-colored wood. A dark blue diagonal bar is at the bottom of the image.

**| WE LOOK
FORWARD TO
SERVING YOUR
NEEDS!**

WHY SHOP AT CLASSIC

- Our trim products are **industry leaders**. Houses with our trim consistently look and sell for a premium.
- Our products are of consistently **high quality**, which you can be assured will remain available for future renovations.
- Our **experienced** staff listen and understand your needs, thereby providing you with an effective solution.
- Our products are **always in stock**, ready for your installation.
- Our stores are **nearby**, making it easy to both pick up materials and visit our showroom.
- Our prices reflect **value** and are below our competition.
- If you don't see what you are looking for give us a call and we will see what we can do.

OUR STORY

Classic has been in the Ottawa Valley for over 30 years. With our consistent honest effort, our company is very fortunate to have expanded to 4 locations and countless homes/renovations and contractors.

www.classicwoodmouldings.com



**| SPECIFIC
NEEDS AT
REASONABLE
PRICES.**

TO THE HOME OWNER

- Great prices
- Four convenient locations
- Very knowledgeable staff
- Delivery available
- In store displays and take home samples
- More then 30 years in business
- Locally owned and managed by people who care
- Large inventory
- Quick and easy service
- Priming services

CUSTOM MILLING

Come in and see us concerning your custom milling needs, either for specific profiles, wood types (Maple, Cherry, Oak etc.), or flexible mouldings. We have a number of custom millings shops, who likely have the knives for your custom millings. At each location we have either a display board, or catalogue to cater to your needs. Custom milling although more expensive than our own products, does provide you with specific needs at reasonable prices.

www.classicwoodmouldings.com

CASINGS & BASEBOARDS

CLASSIC SERIES

*See Annex 1.1 for picture reference

Our longest selling profile casing and base.

Normal combinations are:

- For larger rooms or 9 ft ceilings, base #3 & casing #6.
- For smaller rooms, base #4 & casing #5.
- For large homes, try base #2 with casing #6 and an accompanying backband.

*Available in American Yellow Poplar, Pine, Oak, Fingerjoint Pine, and primed white. #3 and #102 are also available in rubber.

#6 Casing – 3/4" x 3 3/8"
#3 Base – 3/4" x 5 1/4"
#102 1/4 Round – 11/16" x 11/16"

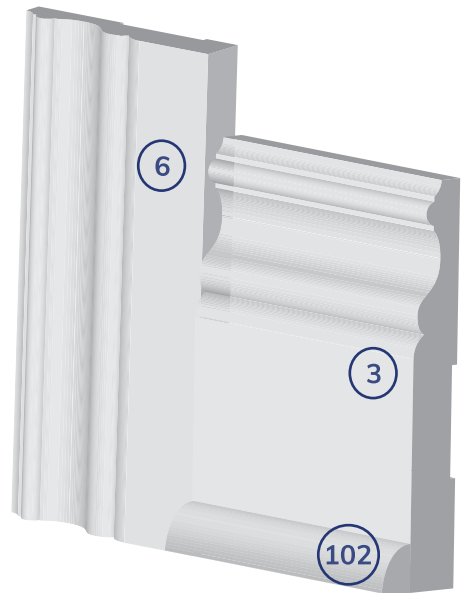

#2 – 3/4" x 7 1/4" (See website)
#3 – 3/4" x 5 1/4"
#4 – 3/4" x 4 1/4"
#6 – 3/4" x 3 3/8"
#5 – 3/4" x 2 1/2"



#5 Casing – 3/4" x 2 1/2"
#4 Base – 3/4" x 4 1/4"
#101 Shoe – 7/16" x 11/16"

HOPPER SERIES

The Hopper Series is always in style. This casing accompanied with headers and backbands are particularly striking.

**Available in Fingerjoint Pine. #101 is also available in rubber.*

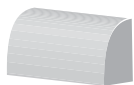

#101 Shoe
7/16" x 11/16"

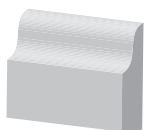

#29 Door Stop/Shoe
1/2" x 1 1/4"

#17 Casing – 3/4" x 3 1/2"

#20 Base – 3/4" x 5 1/2"

#29 Shoe – 1/2" x 1 1/4"



#19 Casing – 3/4" x 2 1/2"

#18 Base – 3/4" x 4 1/2"

#101 Shoe – 7/16" x 11/16"

New Home Trick:

With 3/4" thick moulding, you may not need a shoe for hardwood and ceramic areas.

GLEBE SERIES

Design simplicity at its best. Available in American Yellow Poplar, Fingerjoint Pine and MDF.

#9 Casing – 3/4" x 3 1/8"

#8 Base – 3/4" x 5 1/4" (available in rubber)

#STO 139 – 1/2" x 1 1/4"

#7 Base – 3/4" X 7 1/4" (See website)

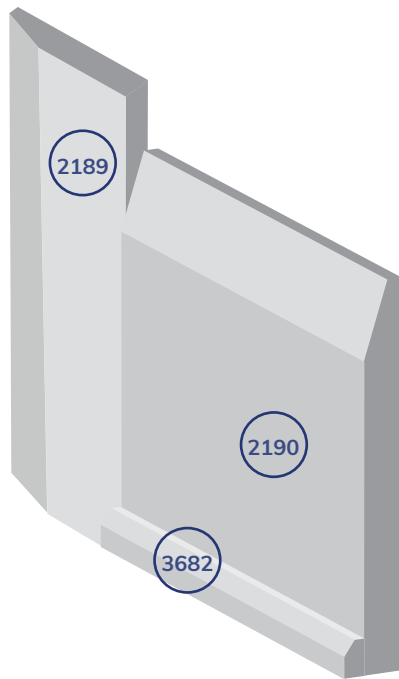
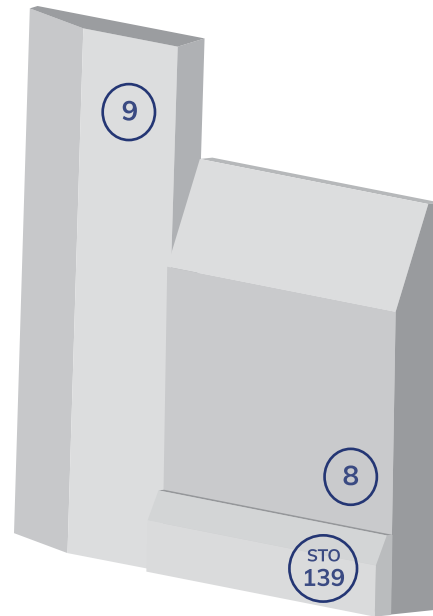

#2189 Casing – 5/8" X 2 3/4"

#2190 Base – 1/2" X 4 3/4"

#3862 Shoe – 7/16" X 11/16"



CONTEMPORARY SERIES

*See Annex 1.2 for picture reference. #1698 is also available in rubber.

#83 Casing – 3/4" x 3 1/2"

#85 Base – 3/4" x 5 1/4"

#1698 – 1/2" X 1 1/4"

#T-97 BACKBAND – 3/4" x 1 1/4"

TORONTO SERIES

A very elegant design made for larger homes.
Also available in Ottawa, despite its name!

**Available in American Yellow Poplar and Fingerjoint Pine.*

- #T-81 Casing – 3/4" x 3 1/2"
- #T-80 Base – 3/4" x 7 1/4"
- #STO 102 – 1/2" x 1 1/2"
- #T-90 BACKBAND – 3/4" x 1 1/4"

**Casing shown here with
T-90 backband.*



TUDOR SERIES



- #22 Casing – 3/4" x 3 1/2"
- #23 Base – 3/4" x 5 1/2"
- #24 Base – 3/4" x 7 1/4"
- #STO 175 – 1/2" x 1 3/4"

Renovation Trick:

When replacing baseboards and casings, select slightly larger profiles and you will cover over paint lines and rough edges.

REGENCY SERIES

An elegant design based from French architecture. Excellent with large crowns. Most popular combination, #37 base with #36 casing.

**Available in Fingerjoint Pine.*

Base Cap – 3/4" X 1 1/4"

D4S – 3/4" x 5 1/2"

#37 – 3/4" x 5 1/4"

#36s – 3/4" x 4 1/4" (See website)

#36 – 3/4" x 3 1/2"

#35 – 3/4" x 2 1/2" (See website)

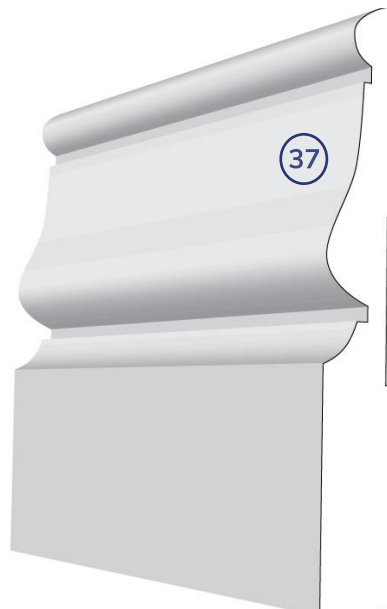
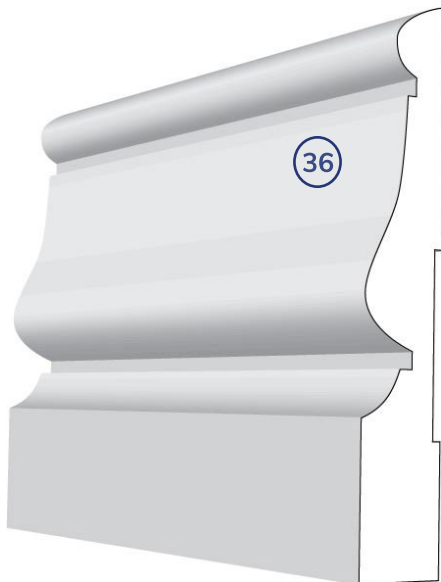
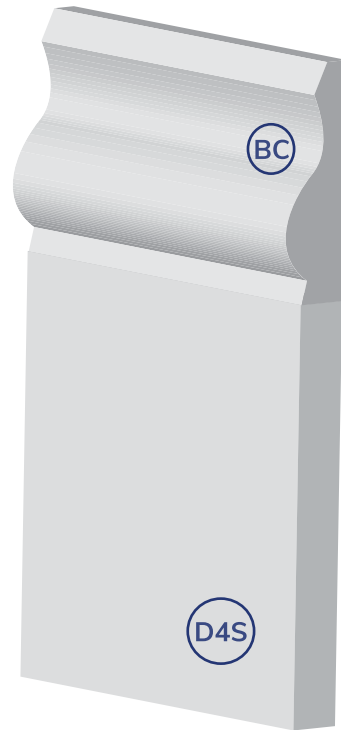

New Home Trick:

To lower costs by using the larger size casings and baseboards in your formal areas and decrease by one size for your bedrooms etc.

SHERWOOD SERIES

Chosen for finer homes for the last 100 years.

**Available in Fingerjoint Pine.*

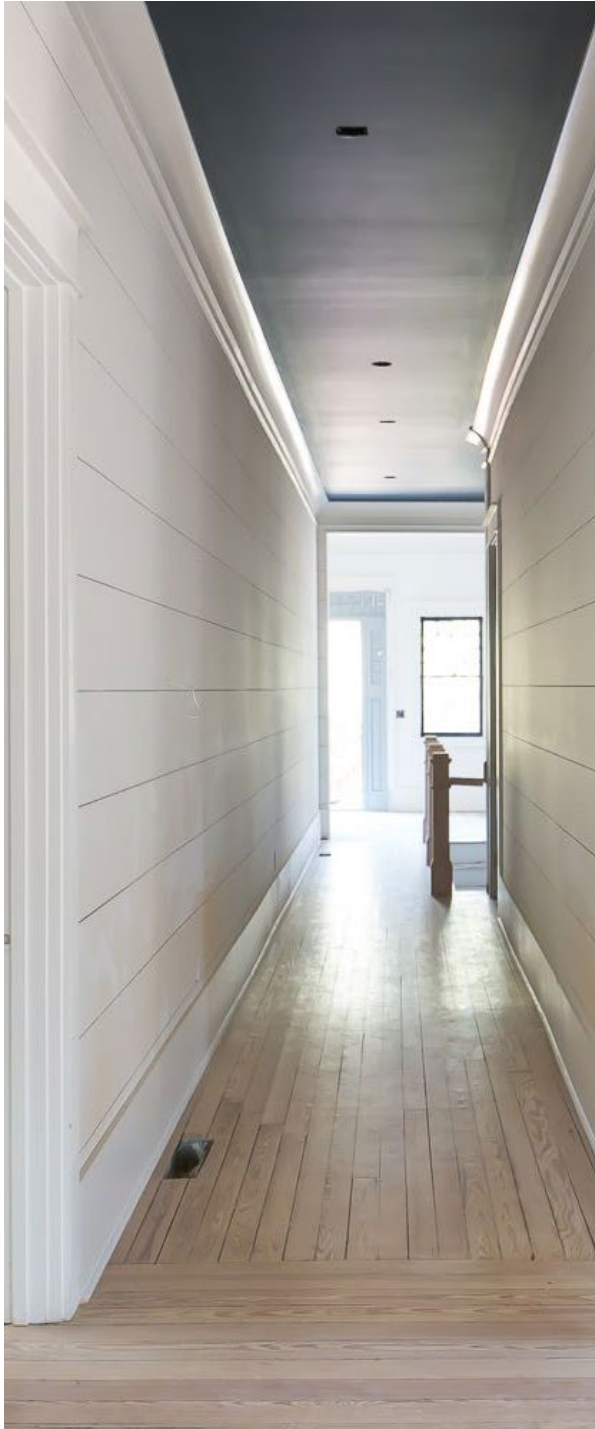

Example of our ship lap above.

**Available in two sizes 2 sizes
1/2" X 7 1/2" and 1/2 x 5 1/2"*

Base: #50 – 3/4" x 7 1/4"

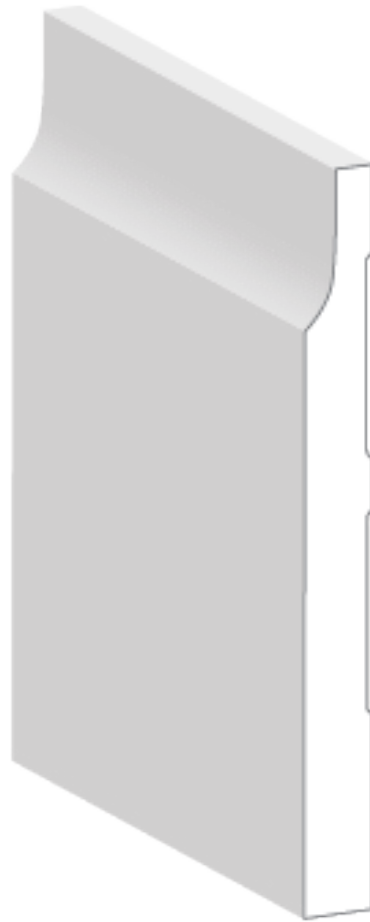

Cap: #51 – 3/4" x 2 1/4"



SIMPLICITY SERIES

These are great dividers. By choosing different colours of wall paint, you can make hallways look larger and more beautiful.

**The simplicity series is now available in MDF.*

Base: D4s – 3/4" x 5 1/2"

Casing: D4s – 3/4" x 3 1/2" or **D45** – 3/4" x 2 1/2"

Header: D45 – 3/4" x 4 1/2" or 3/4" x 5 1/2"

Shoe #8319 – 3/8" x 1 1/4"

**D4S means material has been dressed on all 4 sides.*

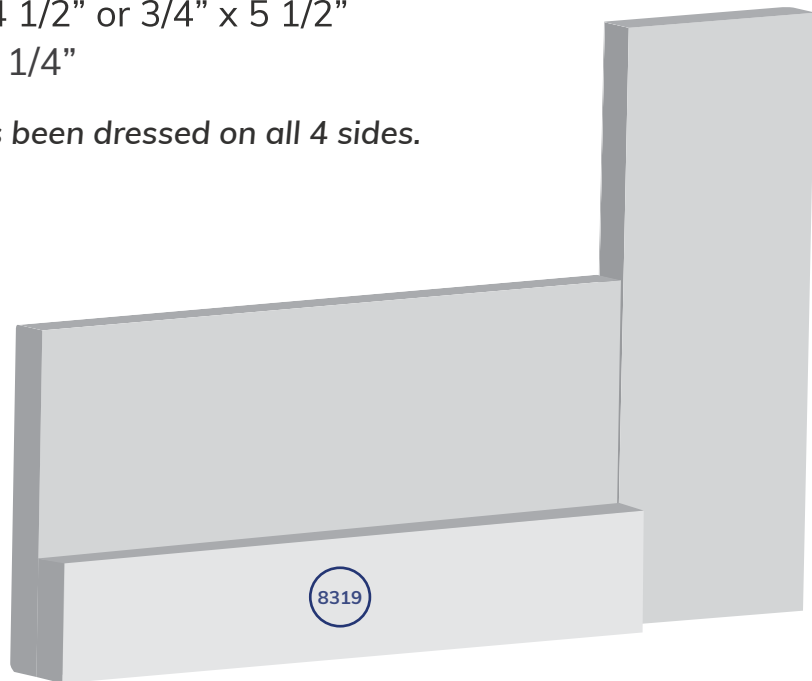

BEVEL SERIES

#214 Casing – 3/4" x 2 1/2"

#508 Base – 3/4" x 5 1/4"

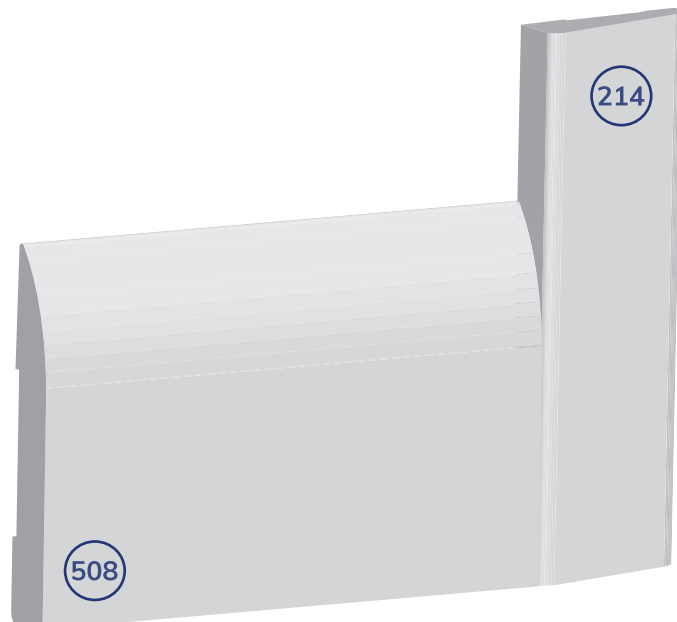

HEADERS

*See Annex 1.3 for picture reference

Headers over formal doorways, living room or dining room entrances are very appealing.

Headers can be either one piece or custom made from a selection of our profiles.

T-89 Header – 1 3/4" x 5 1/4" * Excellent one piece header.

T-91 Header – 1 3/4" x 1 1/2"

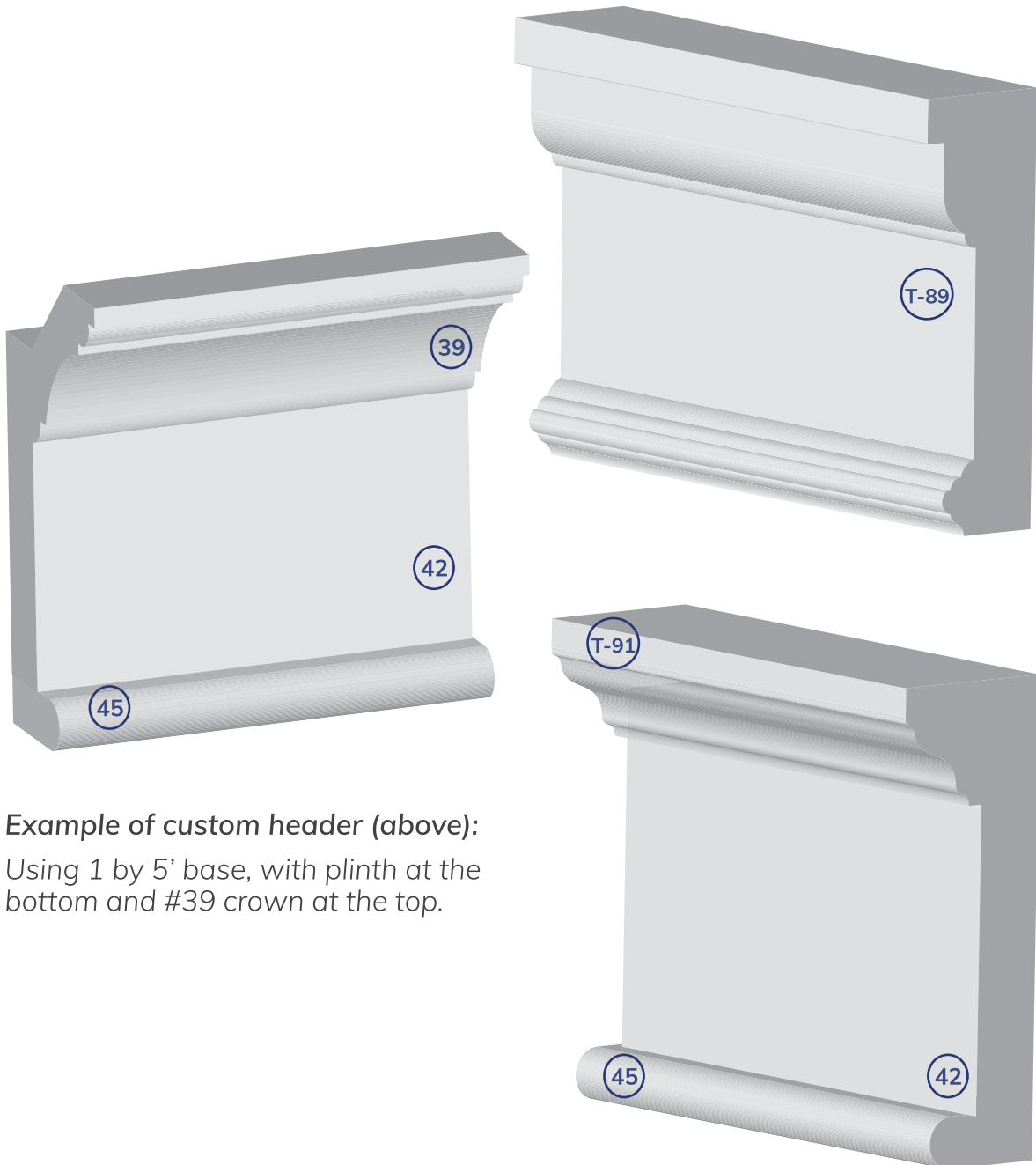

Example of custom header (above):

Using 1 by 5' base, with plinth at the bottom and #39 crown at the top.

QUALITY CROWN MOULDINGS

A sample of our quality Crown Mouldings.



CROWNS

*See Annex 1.4 for picture reference

Crowns continue to grow in popularity. For an 8 foot ceiling, use a 4 1/2" crown and for a 9 foot ceiling use a 5 1/2" crown.

*All crowns available in fingerprint Pine.

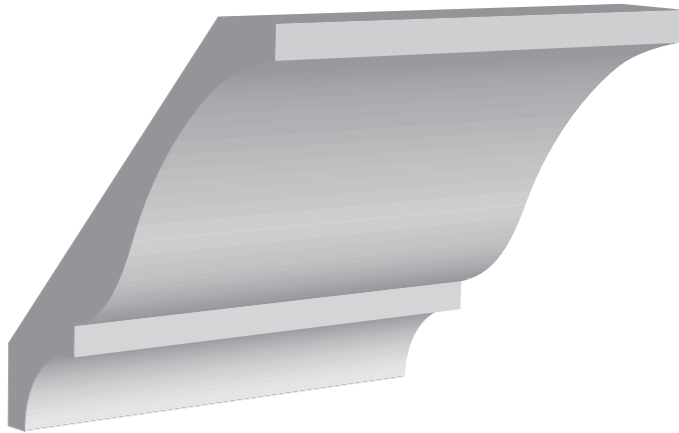

#13a – 3/4" x 5 1/2"
Crown for a 9 foot ceiling or larger.

#13 – 3/4" x 4 1/2"

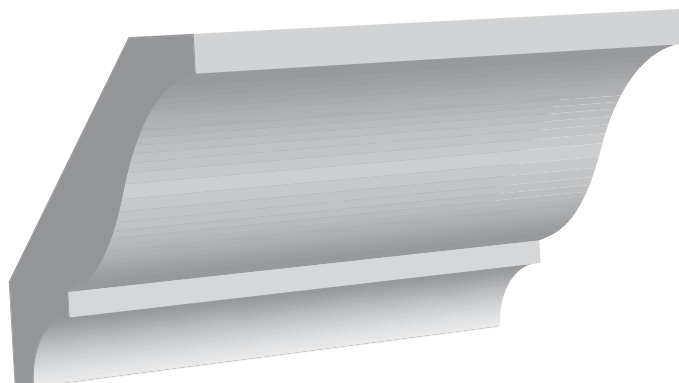
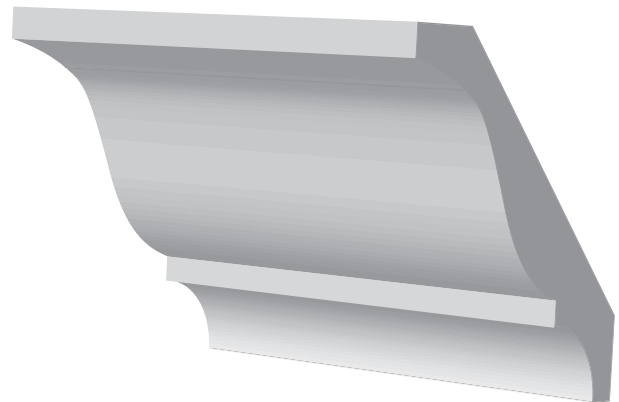

#14 – 3/4" x 3 1/2"
For small rooms, lower ceilings or on cabinets

* Also available in
Clear Pine & Oak

CROWNS

*See Annex 1.5 for picture reference



#16 – 3/4" x 7 1/4"
Very large crown.

#12a – 3/4" x 5 1/2"
More decorative choice.

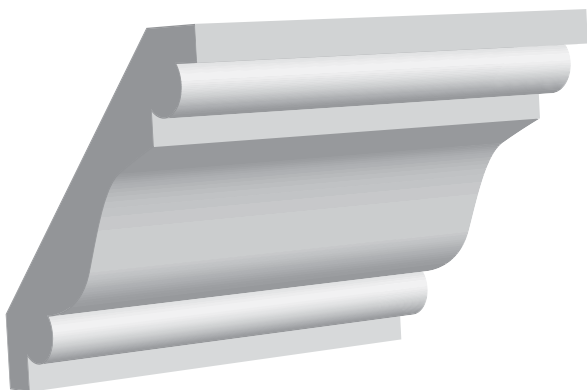
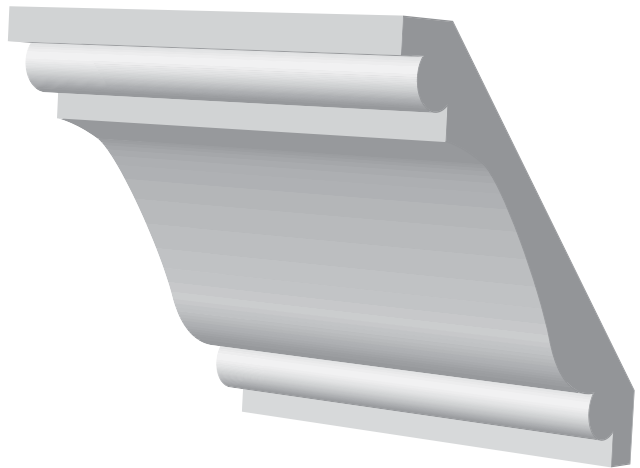

#12 – 3/4" x 4 1/2"
More decorative crown.

CROWNS

*See Annex 1.6 for picture reference

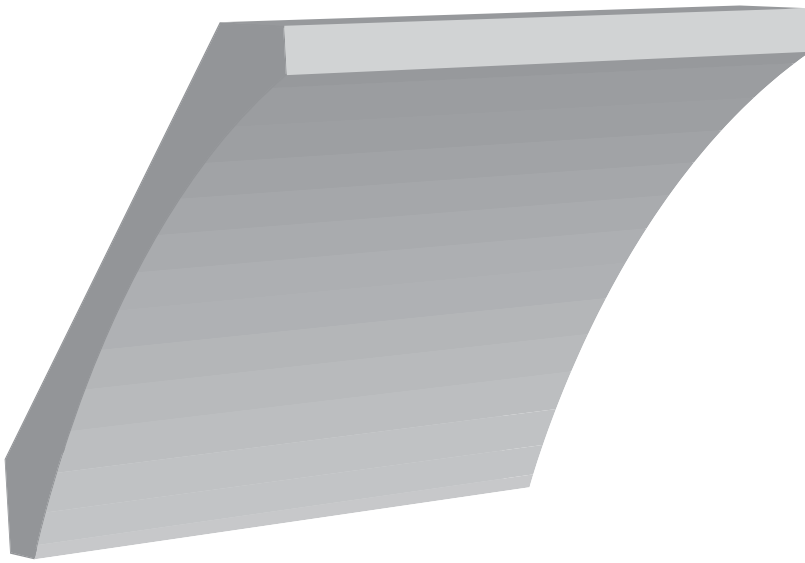

#11a – 3/4" x 5 1/2"
Great for 9 foot ceilings.

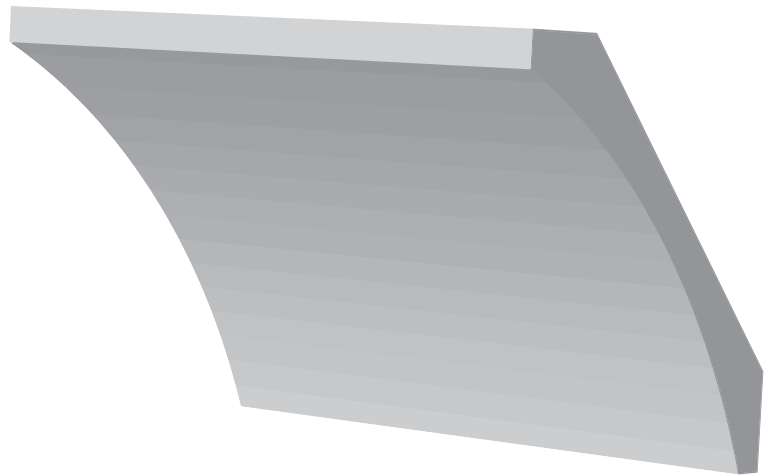

#11 – 3/4" x 4 1/2"
Plain cove to be used
alone or in conjunction
with other trim.

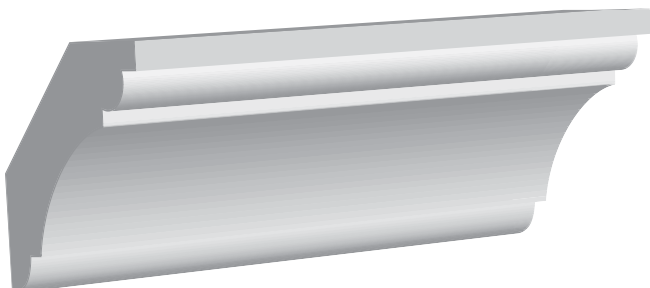

#39 – 3/4" x 2 1/2"
Decorative crown for
headers and cabinets

* Also available in Oak

MDF - Medium Density Fiberboard

COLONIAL SERIES

We carry a growing number of MDF products including economy and up scale profiles.

MDF is popular due to its price and is primed. MDF is ideal for bedrooms and low traffic areas.

Compared to the “Big Box” stores, you will find our products are extremely well priced.

#7705 Casing – 5/8” x 2 3/4”

#5706 Base – 3/8” x 3 7/8”

#101 Shoe – 7/16” x 11/16”

(available in rubber)

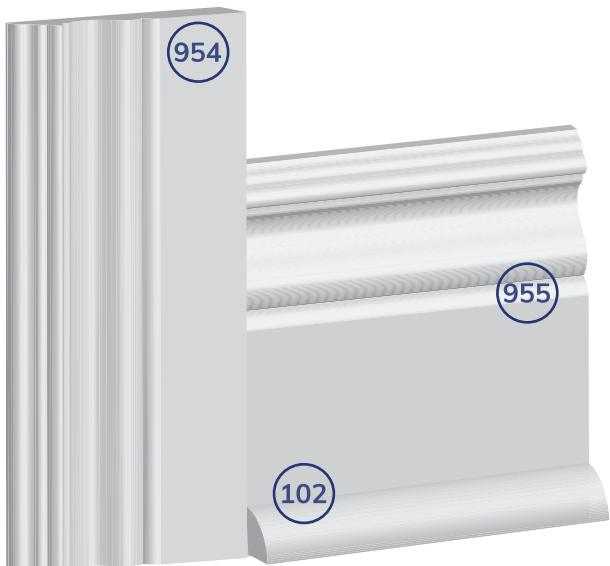

#954 Casing – 3/4” x 3 1/2”

#955 Base – 5/8” x 5 9/16”

(available in rubber)

#102 1/4 Round – 11/16” x 11/16”

(available in rubber)

Tip:

Install chair rail 1 1/2” above your baseboard to achieve a more impressive look.

TUDOR



#7736 Casing – 3/4" x 3 1/2"

#5737 Base – 5/8" x 5 1/2"

(available in rubber)

#1113 Casing – 3/4" x 3 1/2"

#239 Base – 5/8" x 5 1/2"

CHAMFERED



CONTEMPORARY



#1737 Casing – 3/4" x 3 1/2"

#3533 Base – 5/8" x 5 1/2"

(available in rubber)

#1705 Casing – 3/4" x 3 1/2"

#1692 Base – 5/8" x 5 1/2"

ZEN



WEST END

#M9290 Base – 1/2" x 5"
#M9090 Casing – 5/8" x 3"

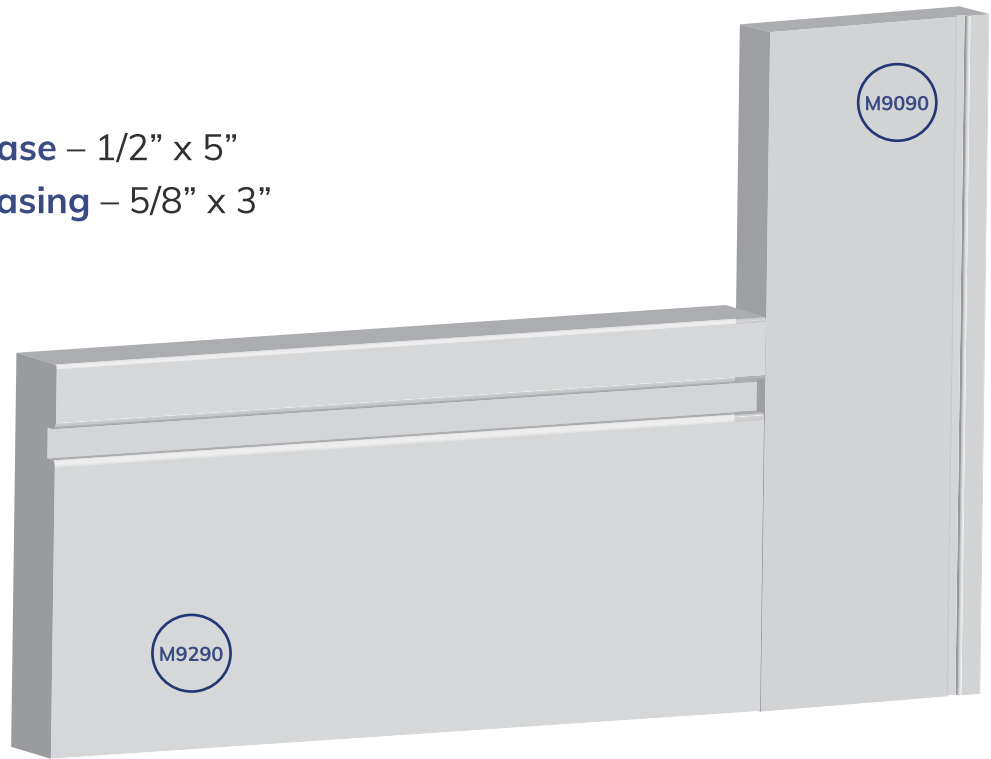

FLAT EASED EDGE

#M5106E Base – 5/8" x 5 1/2"
#M5104E Casing – 5/8" x 3 1/2"

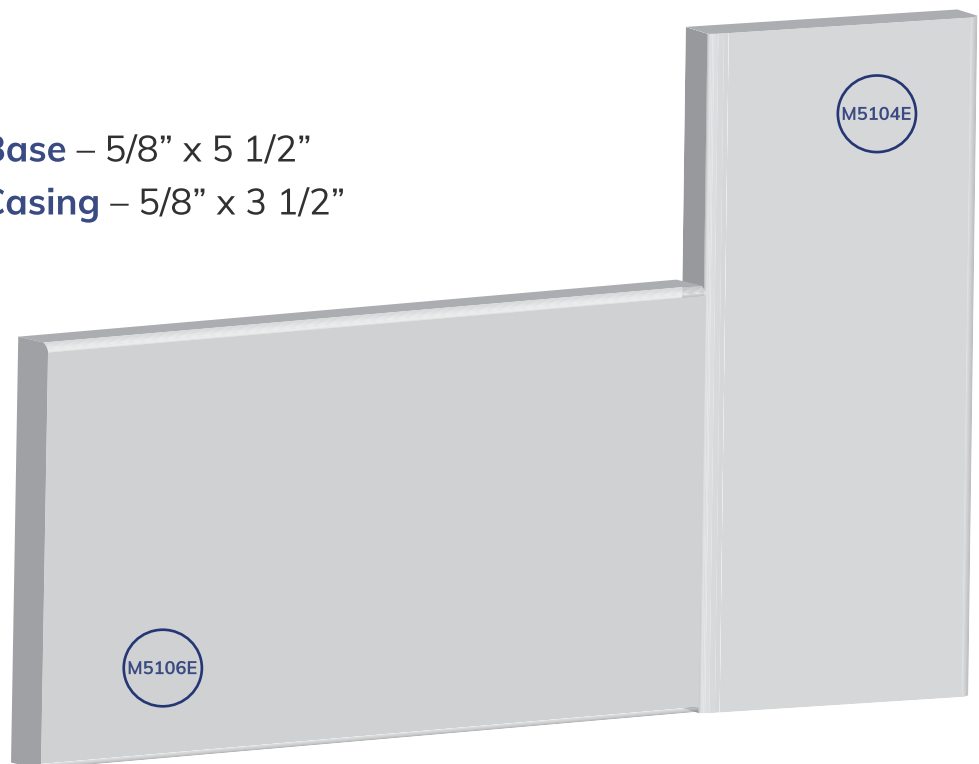

GLEBE SERIES

#GL 7 – 3/4" x 7 1/4" (See website)

#GL 8 – 3/4" x 5 1/2"

#GL 9 – 3/4" x 3 1/8"

#9 MDF Casing – 3/4" x 3 1/8"

#8 MDF Base – 3/4" x 5 1/2"

#STO 139 – 1/2" x 1 1/4"

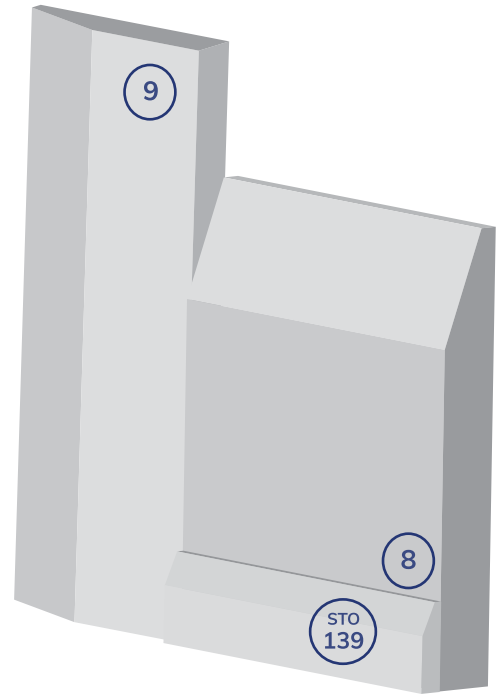

ECONOMY GLEBE

#2189 Case – 5/8" x 2 3/4"

#2190 Base – 1/2" x 4 3/4"

#3682 Shoe – 7/16" x 11/16"
(available in wood)

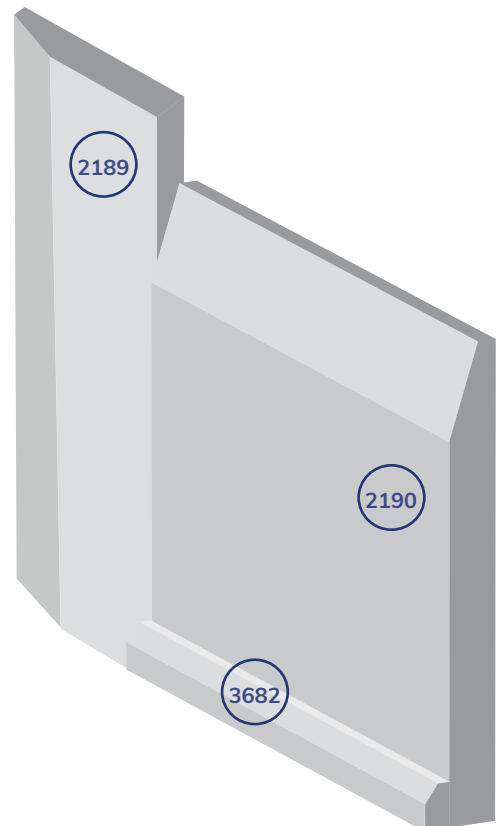

HEADERS

#5015 Header – 1 1/2" x 5 1/2"

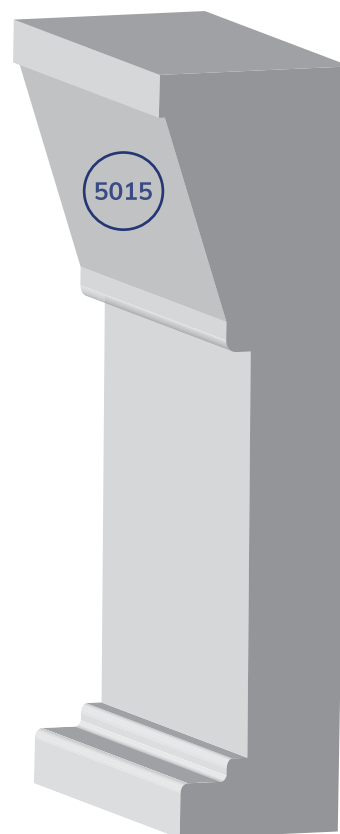

#7712 Header – 1" x 3 5/8"



CROWNS

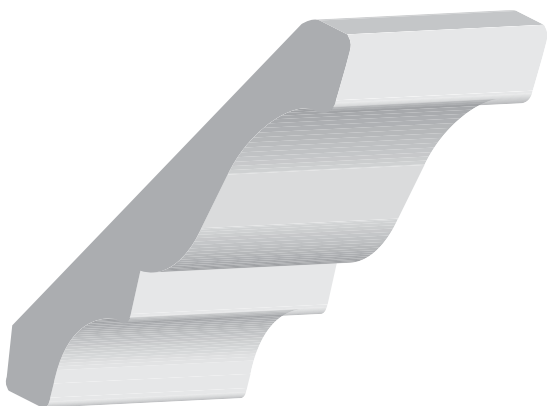

#5180 – 5/8" x 4 1/8"

#5980 – 5/8" x 5 1/4"

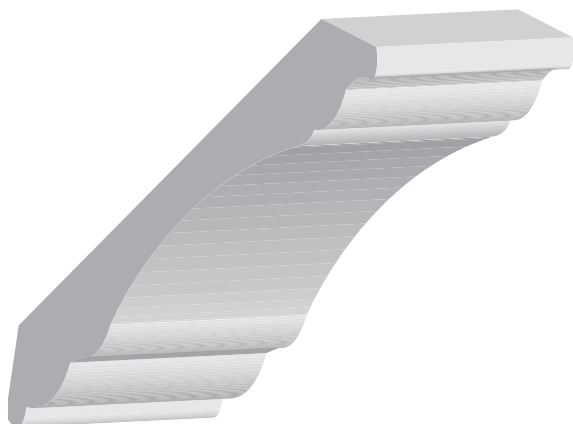
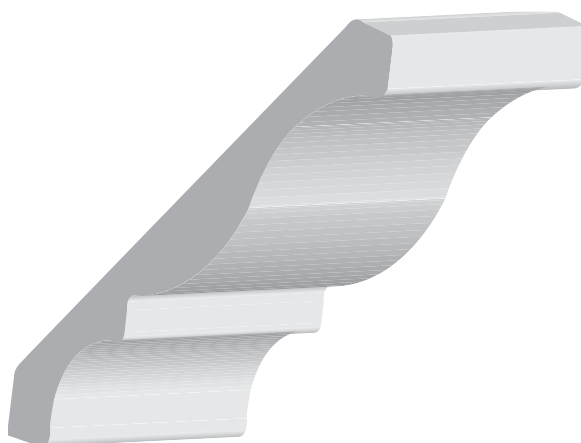

#5982 – 5/8" x 4 1/2"

ECONOMY SERIES

Primed Fingerjoint Moulding

#621 Casing Colonial – 3/8" x 2 1/8" (See website)

#623 Casing Colonial – 3/8" x 2 1/2"

#705 Casing Colonial – 5/8" x 2 3/4"

#111 Casing Bevel – 3/8" x 2 1/2"

#110 Casing Bevel – 3/8" x 2 1/8" (See website)

#622 Baseboard Colonial – 3/8" x 3 1/8"

#624 Baseboard Colonial – 5/16" x 4 1/8"

#130 Baseboard Bevel – 5/16" x 3 1/8"

#623 Casing – 3/8" x 2 1/2"

#622 Base – 3/8" x 3 1/8"



#705 Casing – 5/8" x 2 3/4"

#624 Base – 5/16" x 4 1/8"

#101 Shoe – 7/16" x 11/16"

(available in rubber)

#111 Casing – 3/8" x 2 1/2"

#130 Base – 5/16" x 3 1/8"



CHAIR RAILS

*See Annex 1.7 for picture reference

These are great dividers. By choosing different colours of paint on the walls, you can make hallways look larger and more beautiful.

#21 Chair Rail – 3/4" x 2 1/2"

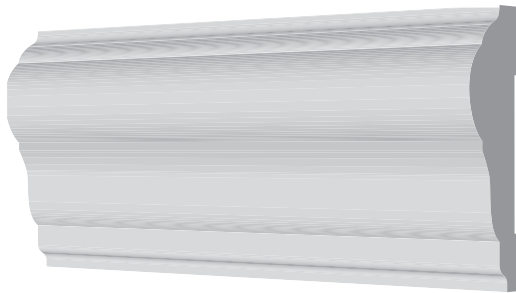

#689 Small Chair Rail – 3/4" x 1 3/4"

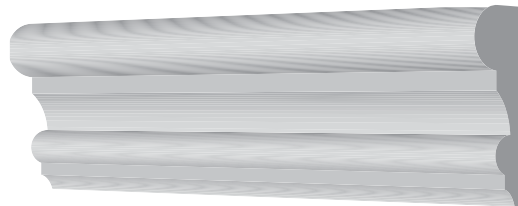

BACKBANDS

Combine a backband with your casing to provide a more tailored look for both door casings and chair rails.

#T-97 Backband – 3/4" x 1 3/8"
with **#GL9 Casing**

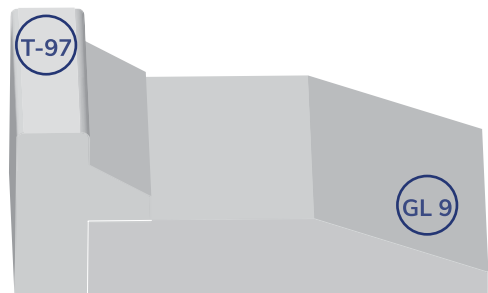

#T-90 Backband – 3/4" x 1 3/8"
with **#6 Casing**

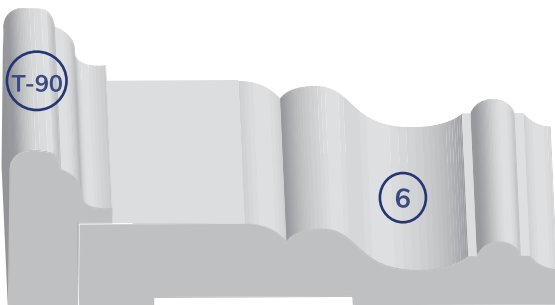

#38 Backband – 3/4" x 1 3/8"
with **#35 Casing**

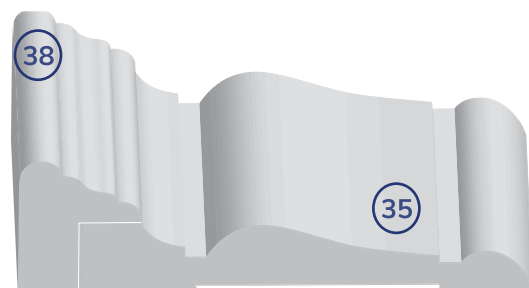

Tip:

Use where gaps exist between baseboards and floors. If you don't like quarter round, try #28 as a classy alternative.

MULLIONS

*See Annex 1.8 for picture reference

#26A Mullion – 3/4" x 1 1/4"



T-96 Raised Panel – 1/2" x 1 3/8"



SILLS

For that special touch use full sills or bullnose for your windows. Can also be used as a plate rail.

*Available in Fingerpoint pine, Pine or Oak.

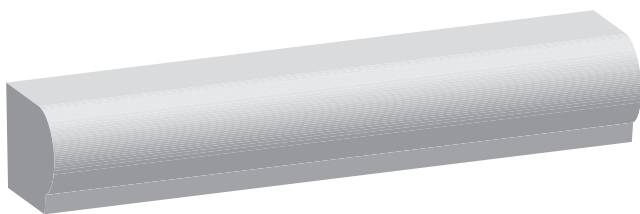

#34S Bullnose – 1 1/4" x 1 1/2"

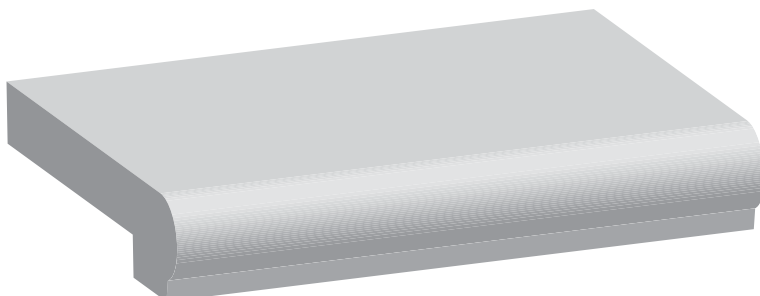

#34 Sills – 1 1/4" x 5 1/2"

FLOORING ACCESSORIES

*See Annex 1.9 for picture reference

All available in oak and maple.

FULL NOSING – 5/4" x 4 1/2"

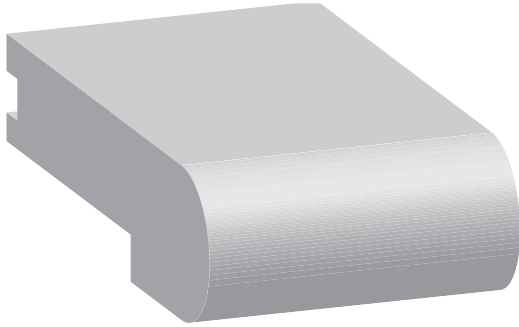

RED 202 | THRESHOLD

2 1/4" x 3/4"

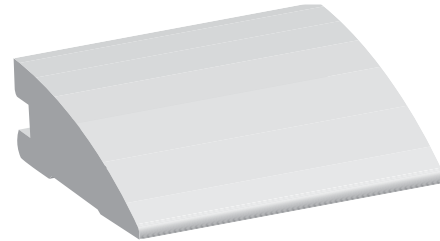

RED 116 | "T" REDUCER

1/2" x 1 3/4"

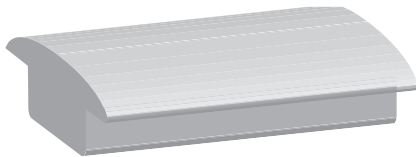

RED 114 | LAMINATE FLOOR REDUCER

– 1/2" x 1 1/16"

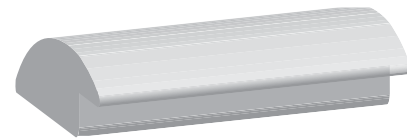

DRESSED FOUR SIDES STOCK - Fingerjoint Products Available Primed

AVAILABLE IN	PINE 7' LENGTH	FINGERJOINT PINE 16'	OAK 6-12'	FINGERJOINT CHILEAN PRIMED16'
1" X 2"		X		X
1" X 3"		X		X
1" X 4"	X	X		X
1" X 5"	X	X	X	X
1" X 6"	X	X		X
1" X 6 5/8"	X	X	X	
1" X 8"	X	X		X
1" X 10"	X			X
1" X 12"				X

DOORS

We are best known for our high quality door jamb kits. This includes full 3/4" jambs, custom door stop and 3 hinges, all pre-hung or pre-machined for fast assembly.



When buying a door kit please provide the door swing as illustrated.

6 PANEL

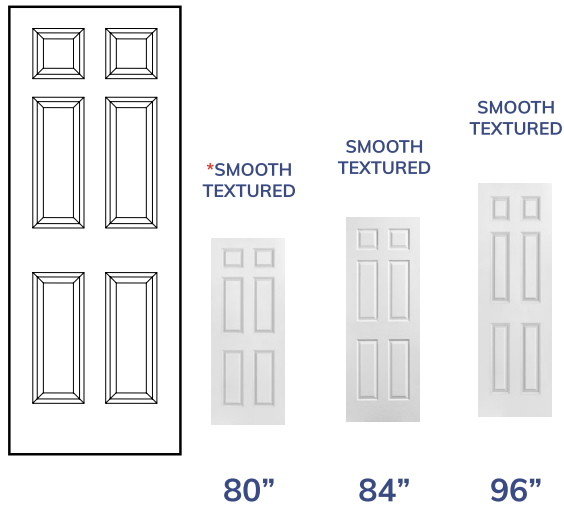

2 PANEL

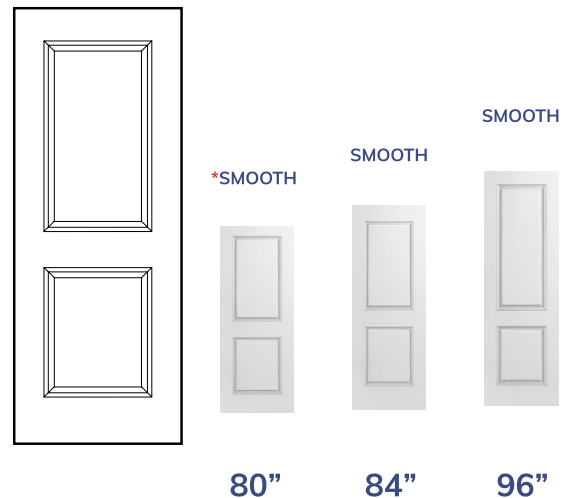

2 PANEL ROMAN

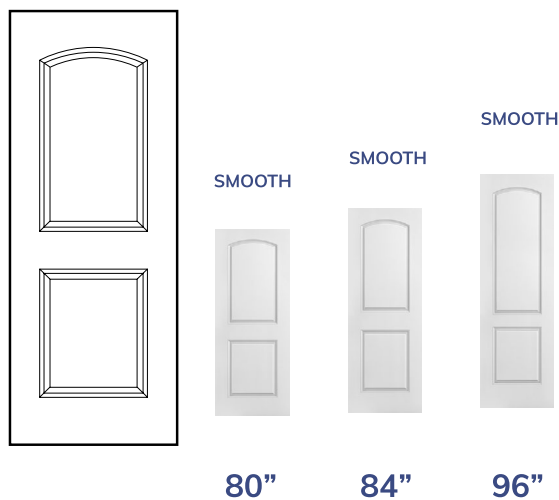

2 PANEL ARCH-TOP

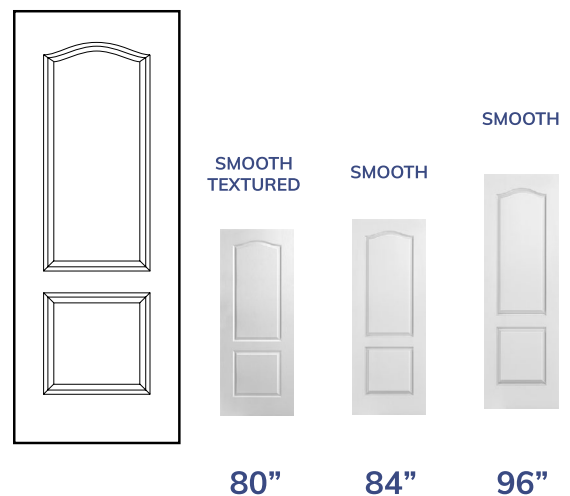

CHEYENNE

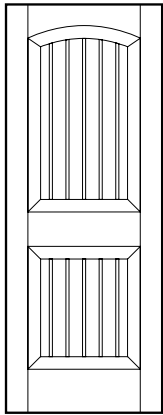

80"



96"

RIVERSIDE

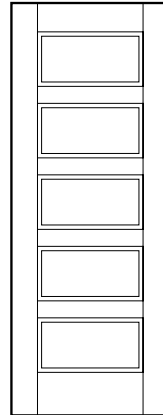

80"



84"



96"

MELROSE

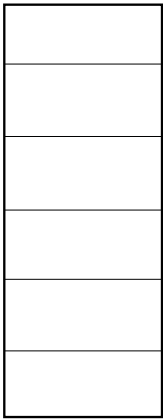

80"



84"

BERKLEY

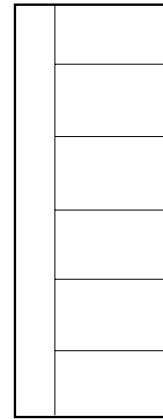

80"



84"

LOGAN

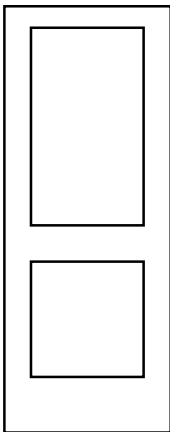

80"



84"



96"

WINSLOW

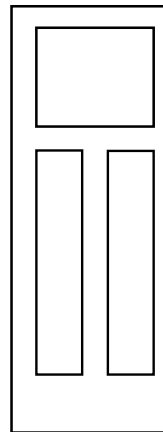

80"



84"



96"

CONMORE

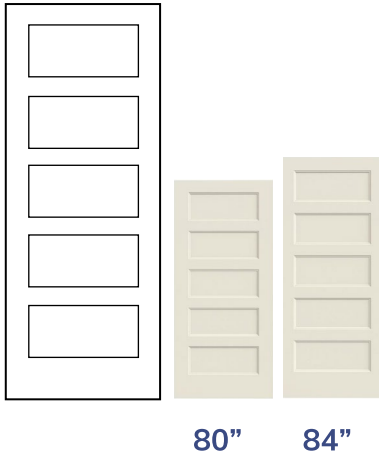

FLUSH HARDBOARD DOOR

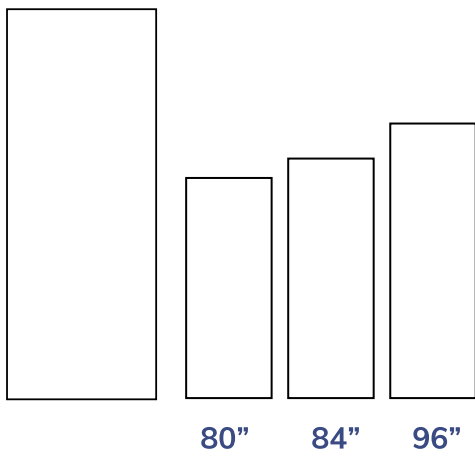

LINCOLN PARK

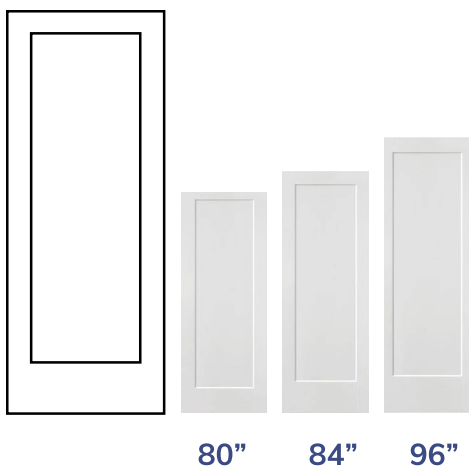

FRENCH DOORS

* All French doors are special order

Many options: Paint Grade, Oak, Maple, Pine, Cherry, Knotty Pine, Douglas Fir *See our showroom for different styles and glass options.

Wood Rail – 4 3/8 (see C30, C40, C55)

Wood Bar – 1 1/4 (see 1501-1596)



WOOD DOORS

* All wood doors are special order

Available in Shaker or Raised Panel.

Solid Core wood doors, Paint Grade. Oak, Maple, Pine, Cherry, Knotty Pine, Douglas Fir.

1 PANEL SHAKER

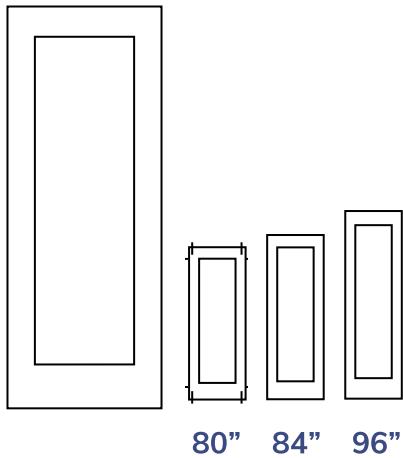

3 PANEL SHAKER

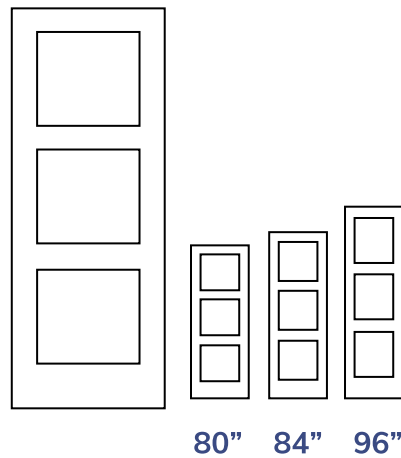

5 PANEL SHAKER

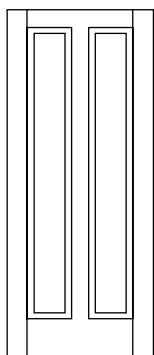
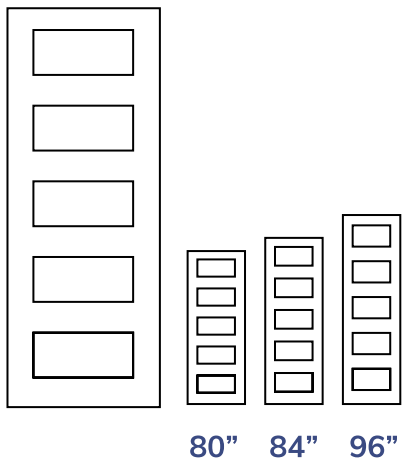

C21

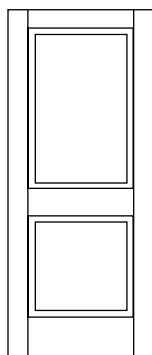

C22

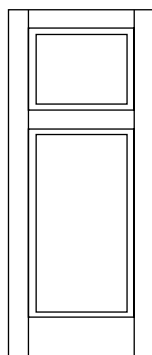

C25

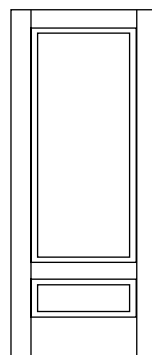

C26

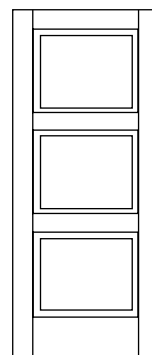

C30

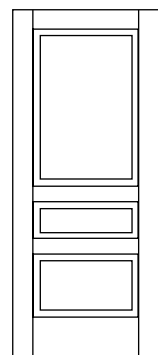

C31

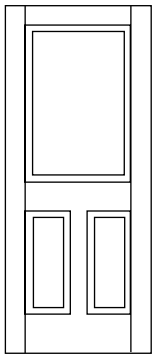

C32

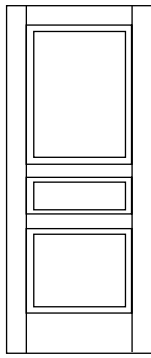

C33

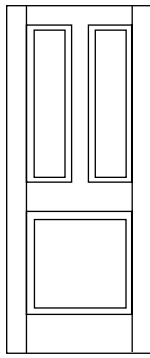

C34

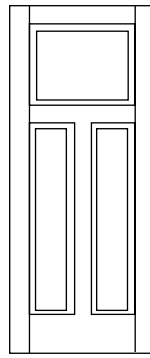

C35

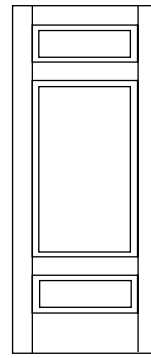

C37

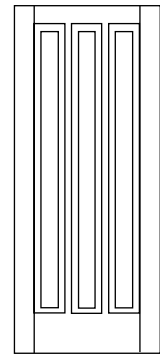

C38

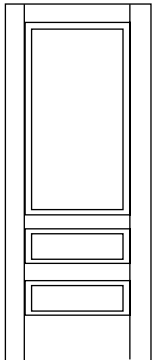

C39

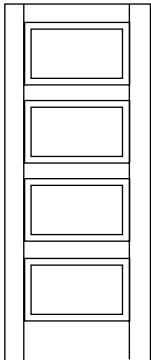

C40

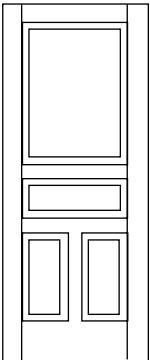

C411

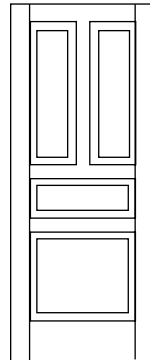

C41

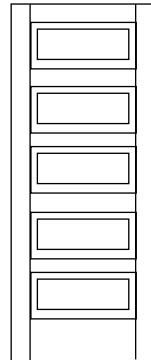

C55

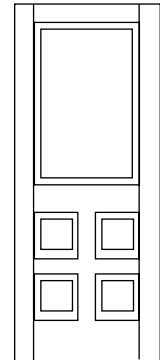

C57

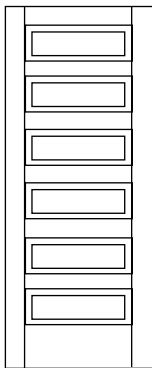

C60

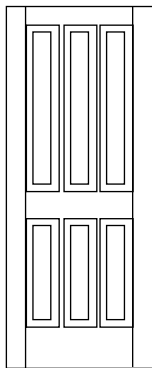

C61

SELECT YOUR PROFILE - STICKING AND PANEL OPTIONS

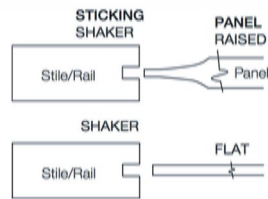
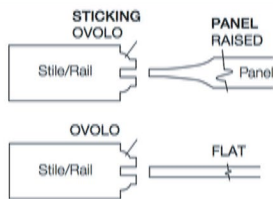

NEW AT CLASSICS

Modern hollow core doors. Shaker look at hollow core pricing! 3 beautiful styles to choose from.

**Also available in solid core for better sound proofing if needed.*



LINCOLN PARK



LOGAN



WINSLOW

HINGES



3x3 Satin Nickel
Square Corners
820NB-B



3x3 Flat Back
Square Corners
820NB-B



3x3 Satin Nickel
Round Corners
2820NB-B



3x3 Antique Nickel
Round Corners
2820AN-B



3x3 Flat Back
Round Corners
2820FB-B



3x3 Oil Rubbed Bronze
Round Corners
2820ORB-B



3x3 Brass
Round Corners
2820B-B



3.5x3.5 Black
Square Corners
821FB-B



3x3 Ball Bearing
Satin Nickel
Square Corners
B848C1533



3.5x3.5 Ball Bearing
Satin Nickel
Square Corners
821NB-B



3.5x3.5 Ball Bearing
Satin Nickel
Round Corners
428212NBB



3.5x3.5 Ball Bearing
Black
Round Corners
428212FB-B



4.5x4 Ball Bearing Spring
Satin Nickel
Square Corners
5823NB-B1



4.5x4 Ball Bearing Spring
Black
Square Corners
5823FB-B1

| DOOR HARDWARE

We carry a complete line of interior door hardware. As always, we have selected products of high quality which we can offer to you at very competitive prices.

When ordering certain door sets, you will need to determine if they are left or right hand. All are available in regular, dummy and lockable modes.

Quality material and high grade finishes.

Available in satin nickel, black, bronze, and brass.

For more finish options, please visit the Canaropa website:
canaropa.com/product-category/residential-door-locks/

KNOBS



BALA



ELINGTON



RONDO

CONDO SERIES - TECHNICA SERIES

Linea and Flat are also available with a square rosette back.



CIRCA



LINEA



FLAT

LEVERS

Quality but inexpensive - Signature Series



EARL



ESCORT



CAMBRIDGE



APOLLO



HAWTHORNE



LIVIA



NERO



CASSIUS



STRAIGHT



WAVE



JUNO



JULIA
(Also available in Square Back)



MANHATTEN



INTERSECT

FINISHES

Several finishes are available in door hardware products. Here are a few popular finishes:

For more information on available finishes, please check with one of our sales associates.



Polished Brass



Antique Brass



Oil Rubbed Bronze



Antique Bronze



Satin Nickel



Antique Nickel



Matte Black



Polished Chrome



Satin Chrome



Endurance/
Lifetime

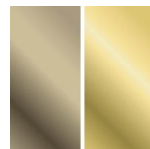

Antique/
Polished
Brass

SUPPLIES



* We now carry Caulking and Cedar Shims.

K. N. CROWDER (KNC) SYSTEMS

Commercial grade pocket door systems by K.N. Crowder available for 2X6 and 2X4 walls in 80"-84" and 96" tall.

kncrowder.com/slidingdoor/pocket-door-systems

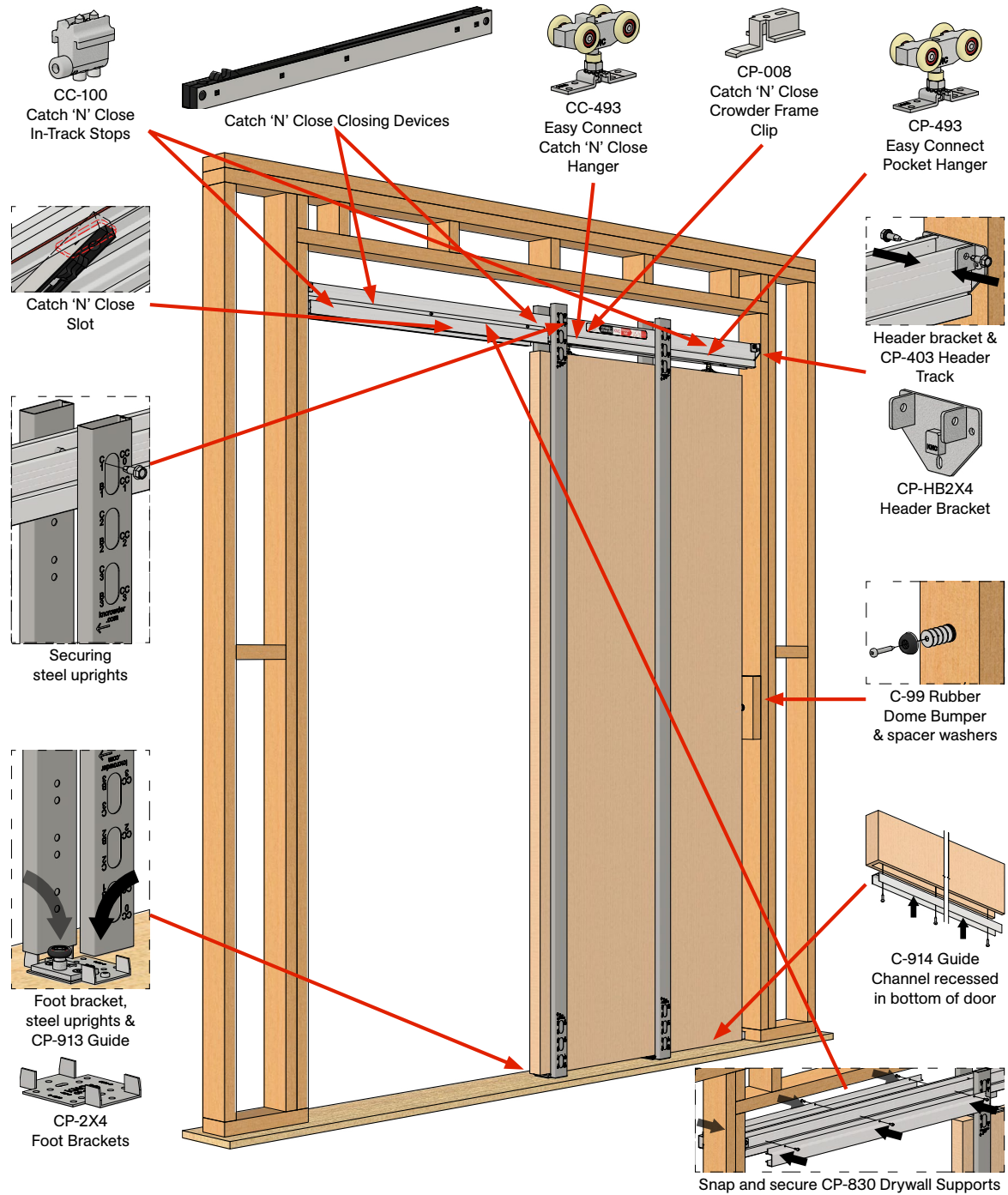



POCKET DOOR KIT



CUT TO SIZE KIT
96', 72', 60', 48'

SLIDING DOOR KIT



CUT TO SIZE KIT
96', 72', 60', 48'



POCKET DOOR

ANNEX 1



1.1 - CLASSIC SERIES

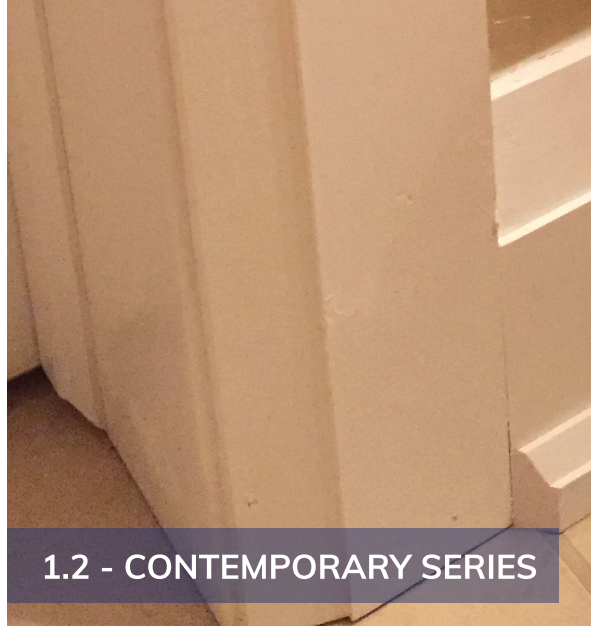

1.2 - CONTEMPORARY SERIES



1.3 - HEADERS

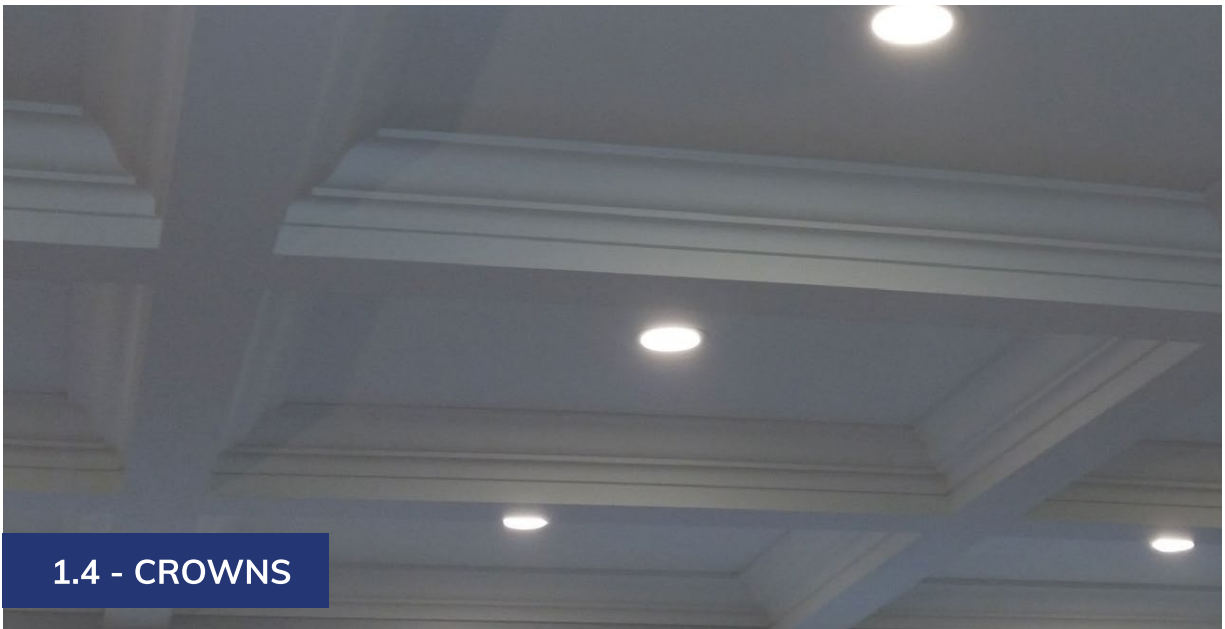

1.4 - CROWNS

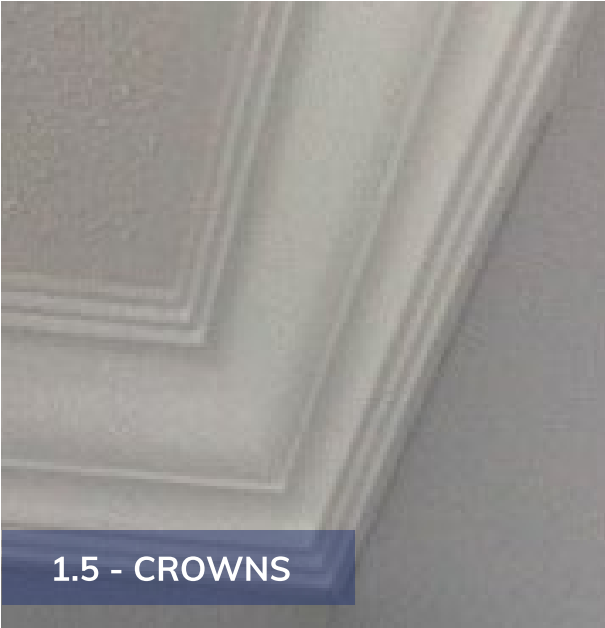

1.5 - CROWNS

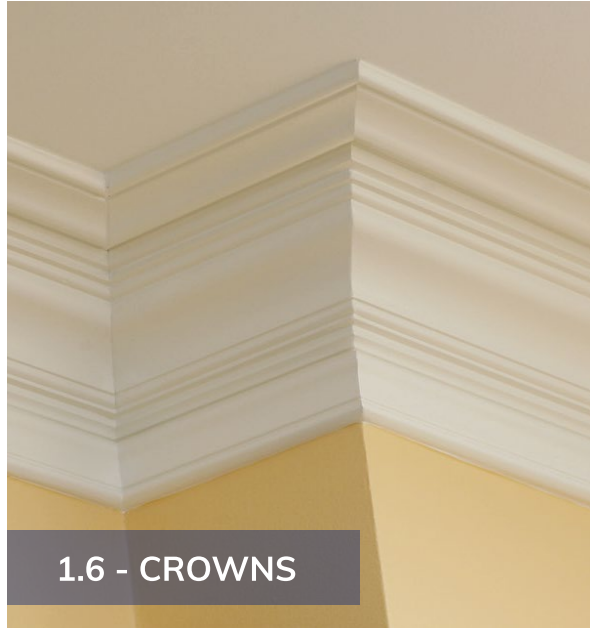

1.6 - CROWNS



1.7 - CHAIR RAILS



1.8 - MULLIONS



1.9 - FLOORING ACCESSORIES

CENTRAL OTTAWA

210 COLONNADE ROAD SOUTH
NEPEAN, ON K2E 7L5

P: 613.225.4782

HOURS:

7:30 - 4:30 MON-THURS

8:00 - 4:30 FRI

9:00 - 12:00 SAT

OTTAWA EAST

1528 STAR TOP ROAD
OTTAWA, ON K1B 3W6

P: 613.748.5000

HOURS:

7:30 - 4:00 MON-FRI

9:00 - 12:00 SAT

OTTAWA WEST

435 MOODIE DRIVE
NEPEAN, ON K2H 8A5

P: 613.820.8000

HOURS:

8:00 - 4:30 MON-FRI

9:00 - 12:00 SAT

TORONTO

24 RONSON DRIVE
TORONTO, ON M9W 1B4

P: 416.241.9380

HOURS:

7:30 - 4:00 MON-FRI

9:00 - 12:00 SAT

